

THIS DRAWING IS THE COPYRIGHT OF ORANGE KEY LTD. IT IS PRIVATE AND CONFIDENTIAL AND IS SUPPLIED ON THE EXPRESS CONDITION THAT IT IS NOT USED FOR ANY PURPOSE OR COPIED OR COMMUNICATED TO ANY OTHER PARTY WITHOUT THE WRITTEN CONSENT OF ORANGE KEY LTD.

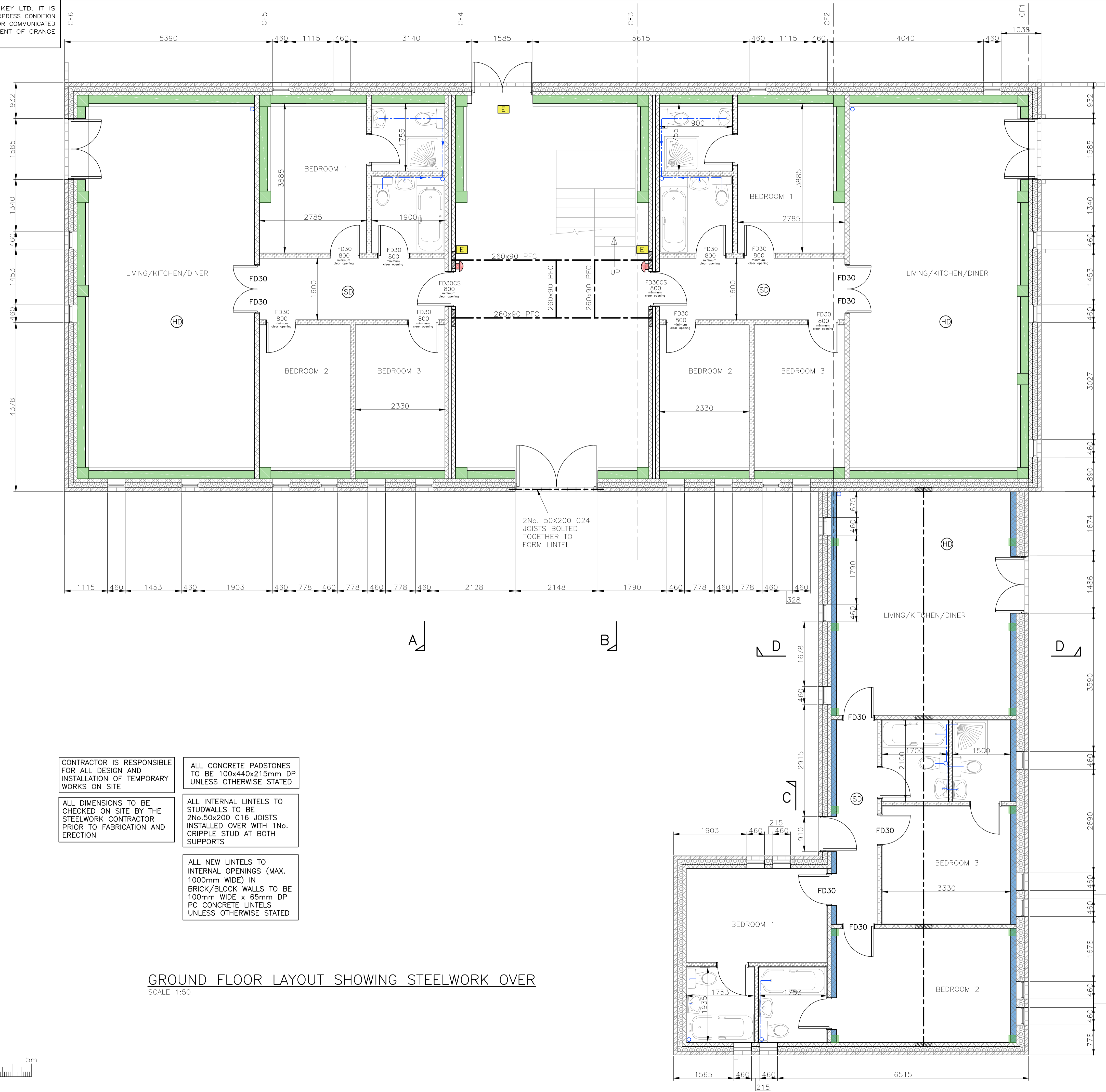

LEGEND	
	FACING BRICKWORK
	7N BLOCKWORK
	100mm STUDWORK
	CONCRETE PADSTONE
	SMOKE DETECTOR (OPTICAL)
	HEAT DETECTOR
	EMERGENCY LIGHTING
	SOUNDER
	FIRE DOOR FITTED WITH INTUMESCENT STRIP
	FIRE DOOR FITTED WITH INTUMESCENT STRIP, COLD SMOKE SEAL AND OVERHEAD SELF CLOSER

- CONTRACTOR IS RESPONSIBLE FOR ALL DESIGN AND INSTALLATION OF TEMPORARY WORKS ON SITE
- ALL DIMENSIONS TO BE CHECKED ON SITE BY THE STEELWORK CONTRACTOR PRIOR TO FABRICATION AND ERECTION
- ALL CONCRETE PADSTONES TO BE 100x440x215mm DP UNLESS OTHERWISE STATED
- ALL INTERNAL LINTELS TO STUDWALLS TO BE 2No. 50x200 C16 JOISTS INSTALLED OVER WITH 1No. CRIPPLE STUD AT BOTH SUPPORTS
- ALL NEW LINTELS TO INTERNAL OPENINGS (MAX. 1000mm WIDE) IN BRICK/BLOCK WALLS TO BE 100mm WIDE x 65mm DP PC CONCRETE LINTELS UNLESS OTHERWISE STATED

GROUND FLOOR LAYOUT SHOWING STEELWORK OVER
SCALE 1:50



REFERENCE DRAWINGS			
REV	DATE	REVISION	OR REVIEW

Orange Key
 Unit 4, The Cuttings
 120 High Street, Hungerford
 Berkshire, RG17 0LU
 Tel: (01488) 682918
 E-mail: info@orangekeyltd.co.uk

Client	JAMES DANIEL CONSTRUCTION		
Project	GREATER BARN HUBBARDS FARM		
Title	GROUND FLOOR LAYOUT		
Scale	AS SHOWN @ A1	Date	OCT 2017
Originator	GEL	Reviewed By	
Drawing number	16092/GB105	Rev.	P2

THIS DRAWING IS THE COPYRIGHT OF ORANGE KEY LTD. IT IS PRIVATE AND CONFIDENTIAL AND IS SUPPLIED ON THE EXPRESS CONDITION THAT IT IS NOT USED FOR ANY PURPOSE OR COPIED OR COMMUNICATED TO ANY OTHER PARTY WITHOUT THE WRITTEN CONSENT OF ORANGE KEY LTD.

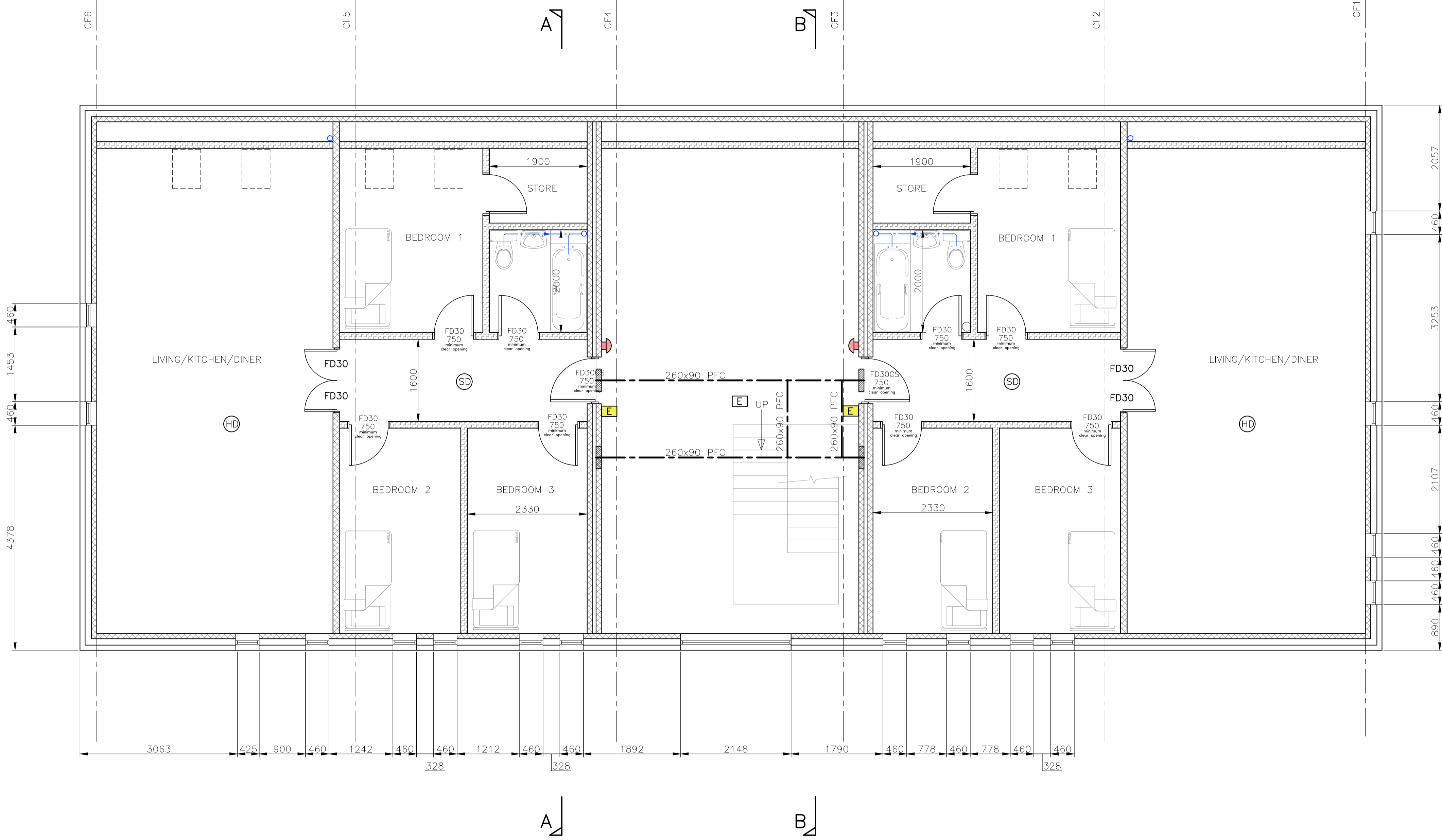

LEGEND

- 7N BLOCKWORK
- 100mm STUDWORK
- CONCRETE PADSTONE
- SMOKE DETECTOR (OPTICAL)
- HEAT DETECTOR
- EMERGENCY LIGHTING
- SOUNDER
- FIRE DOOR FITTED WITH INTUMESCENT STRIP
- FIRE DOOR FITTED WITH INTUMESCENT STRIP, COLD SMOKE SEAL AND OVERHEAD SELF-CLOSER

CONTRACTOR IS RESPONSIBLE FOR ALL DESIGN AND INSTALLATION OF TEMPORARY WORKS ON SITE

ALL DIMENSIONS TO BE CHECKED ON SITE BY THE STEELWORK CONTRACTOR PRIOR TO FABRICATION AND ERECTION

ALL CONCRETE PADSTONES TO BE 100x440x215mm DP UNLESS OTHERWISE STATED

ALL INTERNAL LINTELS TO STUDWALLS TO BE 2No.50x200 C18 JOISTS INSTALLED OVER WITH 1No. CRIPPLE STUD AT BOTH SUPPORTS

ALL NEW LINTELS TO INTERNAL OPENINGS (MAX. 1000mm WIDE) IN BRICK/BLOCK WALLS TO BE 100mm WIDE x 65mm DP PC CONCRETE LINTELS UNLESS OTHERWISE STATED

REFERENCE DRAWINGS			
REV	DATE	REVISION	OR REVIEW

Unit 4, The Cuttings
120 High Street, Hungerford
Berkshire, RG17 0LU
Tel: (01488) 682918
E-mail: info@orangekeyltd.co.uk

Client JAMES DANIEL CONSTRUCTION	
Project GREATER BARN HUBBARDS FARM	
Title FIRST FLOOR LAYOUT	
Scale AS SHOWN @ A1	Date OCT 2017
Originator GEL	Reviewed By
Drawing number 16092/GB106	Rev. P1

FIRST FLOOR LAYOUT SHOWING STEELWORK OVER
SCALE 1:50





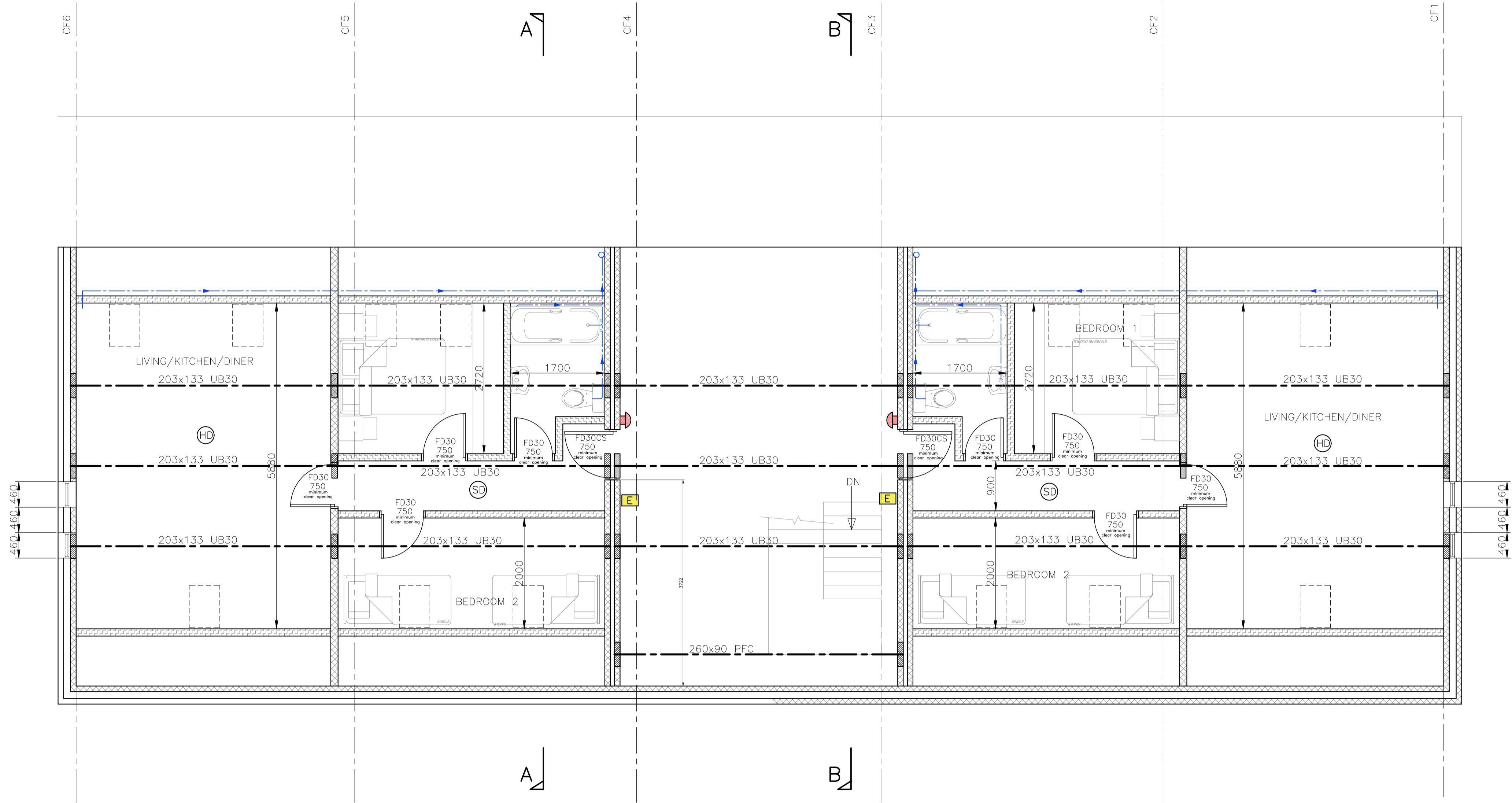



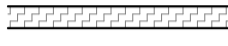

THIS DRAWING IS THE COPYRIGHT OF ORANGE KEY LTD. IT IS PRIVATE AND CONFIDENTIAL AND IS SUPPLIED ON THE EXPRESS CONDITION THAT IT IS NOT USED FOR ANY PURPOSE OR COPIED OR COMMUNICATED TO ANY OTHER PARTY WITHOUT THE WRITTEN CONSENT OF ORANGE KEY LTD.



SECOND FLOOR LAYOUT SHOWING STEELWORK OVER
SCALE: 1:50

LEGEND

-  7N BLOCKWORK
-  100mm STUDWORK
-  CONCRETE PADSTONE
-  SMOKE DETECTOR (OPTICAL)
-  HEAT DETECTOR
-  EMERGENCY LIGHTING
-  SOUNDER
-  FD30
FIRE DOOR FITTED WITH INTUMESCENT STRIP
-  FD30CS
FIRE DOOR FITTED WITH INTUMESCENT STRIP, COLD SMOKE SEAL AND OVERHEAD SELF CLOSER

CONTRACTOR IS RESPONSIBLE FOR ALL DESIGN AND INSTALLATION OF TEMPORARY WORKS ON SITE

ALL CONCRETE PADSTONES TO BE 100x440x215mm DP UNLESS OTHERWISE STATED

ALL DIMENSIONS TO BE CHECKED ON SITE BY THE STEELWORK CONTRACTOR PRIOR TO FABRICATION AND ERECTION

ALL INTERNAL LINTELS TO STUDWALLS TO BE 2No.50x200 C16 JOISTS INSTALLED OVER WITH 1No. CRIPPLE STUD AT BOTH SUPPORTS

ALL NEW LINTELS TO INTERNAL OPENINGS (MAX. 1000mm WIDE) IN BRICK/BLOCK WALLS TO BE 100mm WIDE x 65mm DP PC CONCRETE LINTELS UNLESS OTHERWISE STATED

REFERENCE DRAWINGS

REV	DATE	REVISION	OR	REVIEW



Unit 4, The Cuttings
120 High Street, Hungerford
Berkshire, RG17 0LU
Tel: (01488) 682918
E-mail: info@orangekeyltd.co.uk

Client
JAMES DANIEL CONSTRUCTION

Project
**GREATER BARN
HUBBARDS FARM**

Title
SECOND FLOOR LAYOUT

Scale AS SHOWN @ A1 Date OCT 2017

Originator GEL Reviewed By

Drawing number

16092/GB107

Rev.

P1

THIS DRAWING IS THE COPYRIGHT OF ORANGE KEY LTD. IT IS PRIVATE AND CONFIDENTIAL AND IS SUPPLIED ON THE EXPRESS CONDITION THAT IT IS NOT USED FOR ANY PURPOSE OR COPIED OR COMMUNICATED TO ANY OTHER PARTY WITHOUT THE WRITTEN CONSENT OF ORANGE KEY LTD.

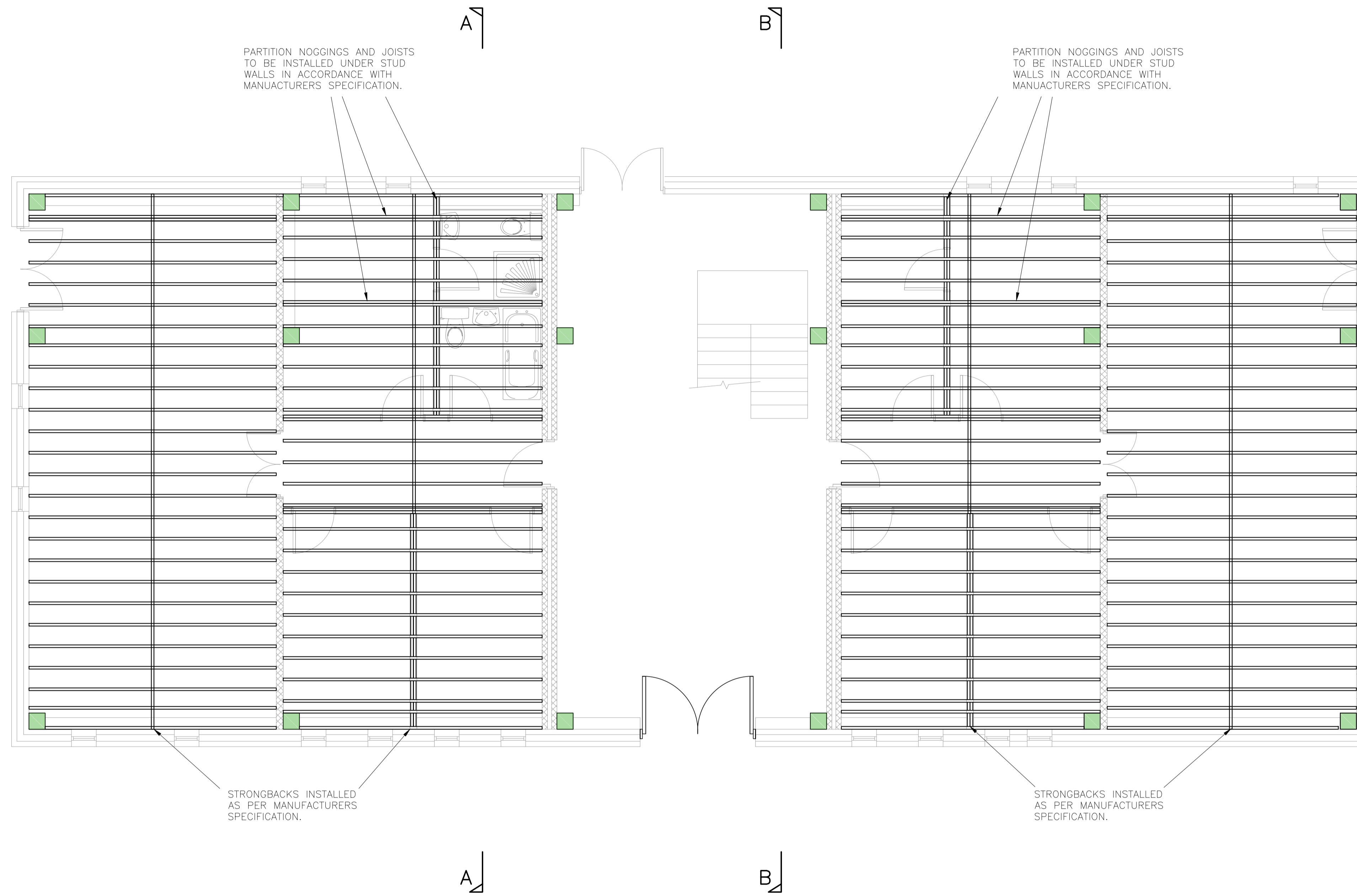

JOISTS TO BE FULLY STRAPPED IN ACCORDANCE WITH THE BUILDING REGULATIONS USING 30x5mm GALVANISED LATERAL RESTRAINT STRAPS FIXED DOWN INSIDE FACE OF CAVITY WALL.

ALL FLOOR JOIST TO BE WS200 EASI-JOISTS @ 400 CRS. FINAL DESIGN AND LAYOUT TO BE SPECIFIED BY MANUFACTURER.

STRONGBACKS INSTALLED AS PER MANUFACTURERS SPECIFICATION.

STRONGBACKS INSTALLED AS PER MANUFACTURERS SPECIFICATION.

PROPOSED FIRST FLOOR JOIST LAYOUT
SCALE 1:50

REFERENCE DRAWINGS			
REV	DATE	REVISION	OR REVIEW



Unit 4, The Cuttings
120 High Street, Hungerford
Berkshire, RG17 0LU
Tel: (01488) 629110
E-mail: info@orangekeyltd.co.uk

Client	JAMES DANIEL CONSTRUCTION		
Project	GREATER BARN HUBBARDS FARM		
Title	PROPOSED FIRST FLOOR JOIST LAYOUT		
Scale	AS SHOWN @ A1	Date	OCT 2017
Originator	GEL	Reviewed By	
Drawing number	16092/GB108	Rev.	P1

THIS DRAWING IS THE COPYRIGHT OF ORANGE KEY LTD. IT IS PRIVATE AND CONFIDENTIAL AND IS SUPPLIED ON THE EXPRESS CONDITION THAT IT IS NOT USED FOR ANY PURPOSE OR COPIED OR COMMUNICATED TO ANY OTHER PARTY WITHOUT THE WRITTEN CONSENT OF ORANGE KEY LTD.

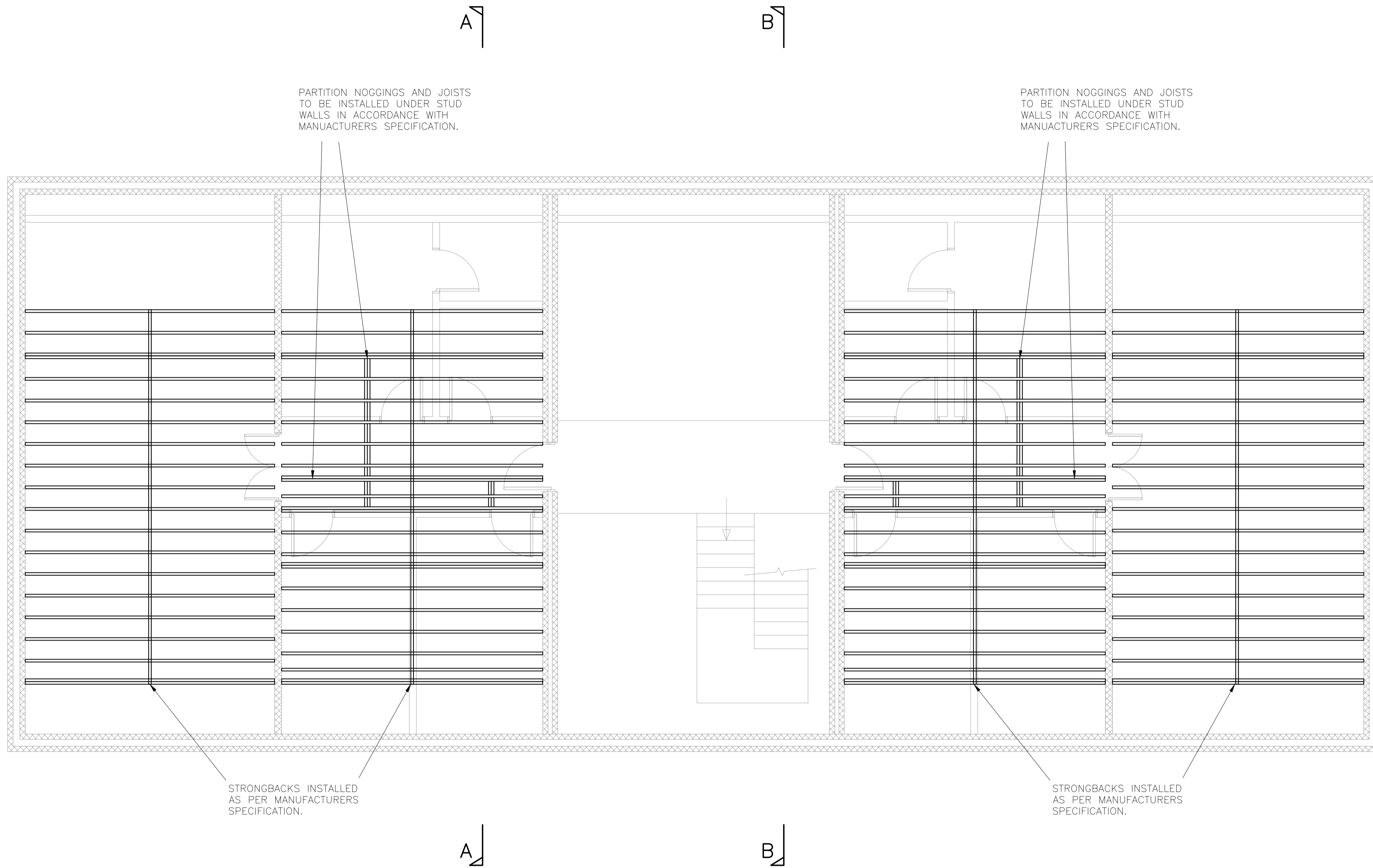

JOISTS TO BE FULLY STRAPPED IN ACCORDANCE WITH THE BUILDING REGULATIONS USING 30x5mm GALVANISED LATERAL RESTRAINT STRAPS FIXED DOWN INSIDE FACE OF CAVITY WALL.

ALL FLOOR JOIST TO BE WS200 EASI-JOISTS @ 400 CRS. FINAL DESIGN AND LAYOUT TO BE SPECIFIED BY MANUFACTURER.

STRONGBACKS INSTALLED AS PER MANUFACTURERS SPECIFICATION.

STRONGBACKS INSTALLED AS PER MANUFACTURERS SPECIFICATION.

PROPOSED SECOND FLOOR JOIST LAYOUT

SCALE 1:50

REFERENCE DRAWINGS			
REV	DATE	REVISION	OR REVIEW

Orange Key
 Unit 4, The Cuttings
 120 High Street, Hungerford
 Berkshire, RG17 0LU
 Tel: (01488) 629110
 E-mail: info@orangekeyltd.co.uk

Client JAMES DANIEL CONSTRUCTION	
Project GREATER BARN HUBBARDS FARM	
Title PROPOSED SECOND FLOOR JOIST LAYOUT	
Scale AS SHOWN @ A1	Date OCT 2017
Originator GEL	Reviewed By
Drawing number 16092/GB109	Rev. P1

THIS DRAWING IS THE COPYRIGHT OF ORANGE KEY LTD. IT IS PRIVATE AND CONFIDENTIAL AND IS SUPPLIED ON THE EXPRESS CONDITION THAT IT IS NOT USED FOR ANY PURPOSE OR COPIED OR COMMUNICATED TO ANY OTHER PARTY WITHOUT THE WRITTEN CONSENT OF ORANGE KEY LTD.

ALL VELUX WINDOWS TO BE GGL CK06
550x1180 (CONSERVATION WINDOWS)

WHERE TIMBERS ARE SHOWN LAID TOGETHER, FIX USING M16 BOLTS @ NOMINAL 500 STAGGERED CRS INCL. #30mm WASHERS

ROOF AND CEILING/FLOOR JOISTS TO BE FULLY STRAPPED IN ACCORDANCE WITH THE BUILDING REGULATIONS USING 30x5mm GALVANISED LATERAL RESTRAINT STRAPS FIXED TO INSIDE FACE OF CAVITY WALL AND ACROSS 3No. MIN. TIMBERS

ALL NEW RAFTERS TO BE 50 x 200 C24 @ 400 CRS

DOUBLE RAFTERS TO SIDES OF ALL VELUX WINDOWS

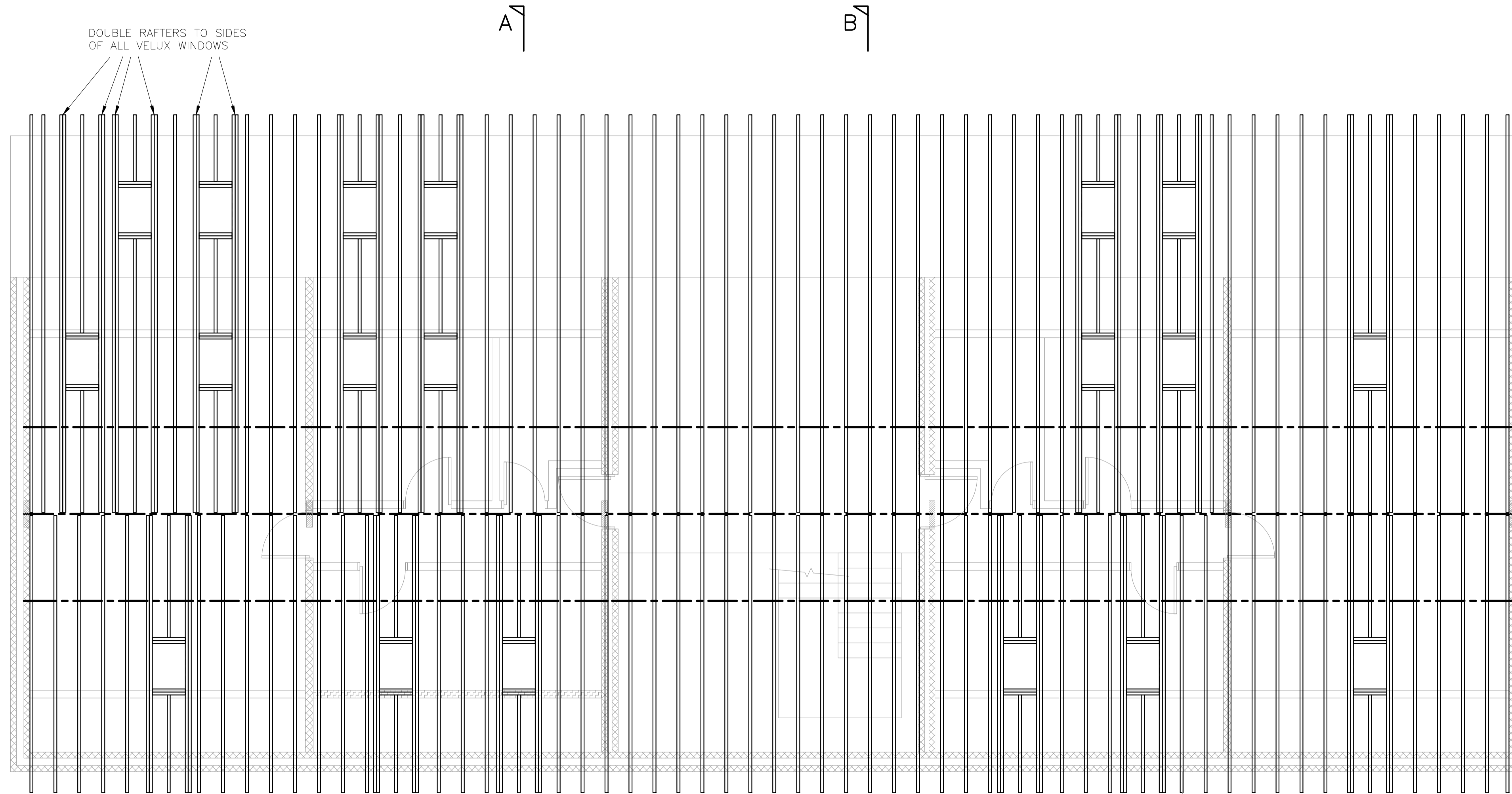

A

B

PROPOSED ROOF LAYOUT
SCALE 1:50

REFERENCE DRAWINGS

REV	DATE	REVISION	OR	REVIEW



Unit 4, The Cuttings
120 High Street, Hungerford
Berkshire, RG17 0LU
Tel: (01488) 622918
E-mail: info@orangekeytd.co.uk

Client
JAMES DANIEL CONSTRUCTION

Project
**GREATER BARN
HUBBARDS FARM**

Title
**PROPOSED ROOF LAYOUT TO MAIN
BLOCK**

Scale AS SHOWN @ A1 Date OCT 2017

Originator GEL Reviewed By

Drawing number Rev.

16092/GB110

P1

THIS DRAWING IS THE COPYRIGHT OF ORANGE KEY LTD. IT IS PRIVATE AND CONFIDENTIAL AND IS SUPPLIED ON THE EXPRESS CONDITION THAT IT IS NOT USED FOR ANY PURPOSE OR COPIED OR COMMUNICATED TO ANY OTHER PARTY WITHOUT THE WRITTEN CONSENT OF ORANGE KEY LTD.

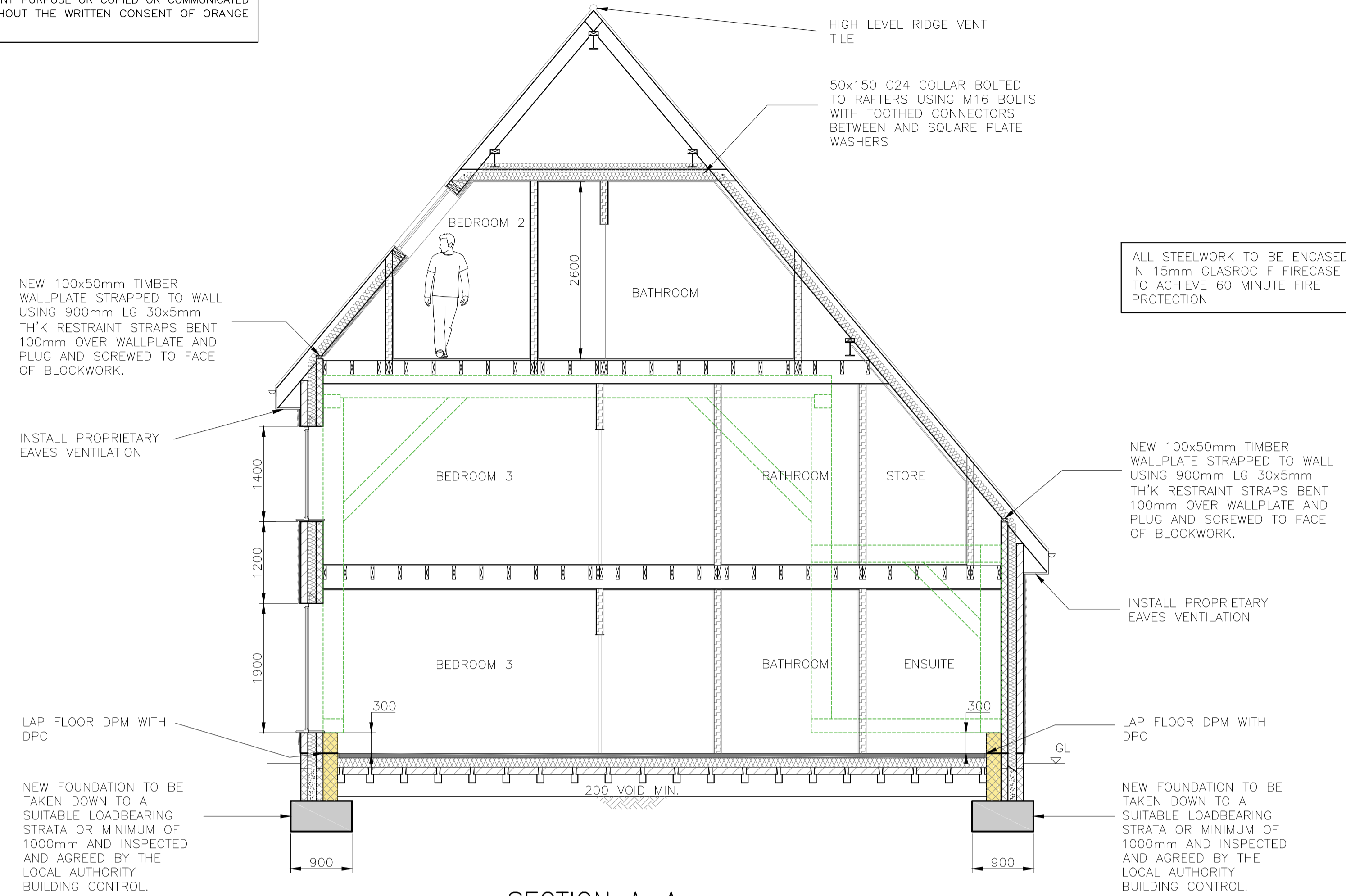

SECTION A-A
SCALE 1:50

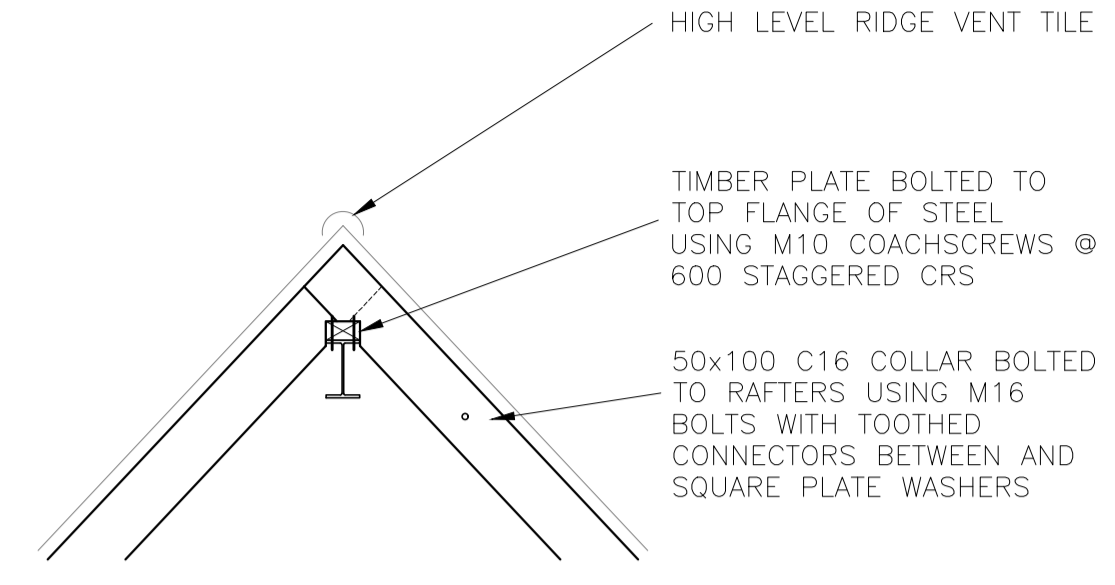

RIDGE DETAIL
SCALE 1:20

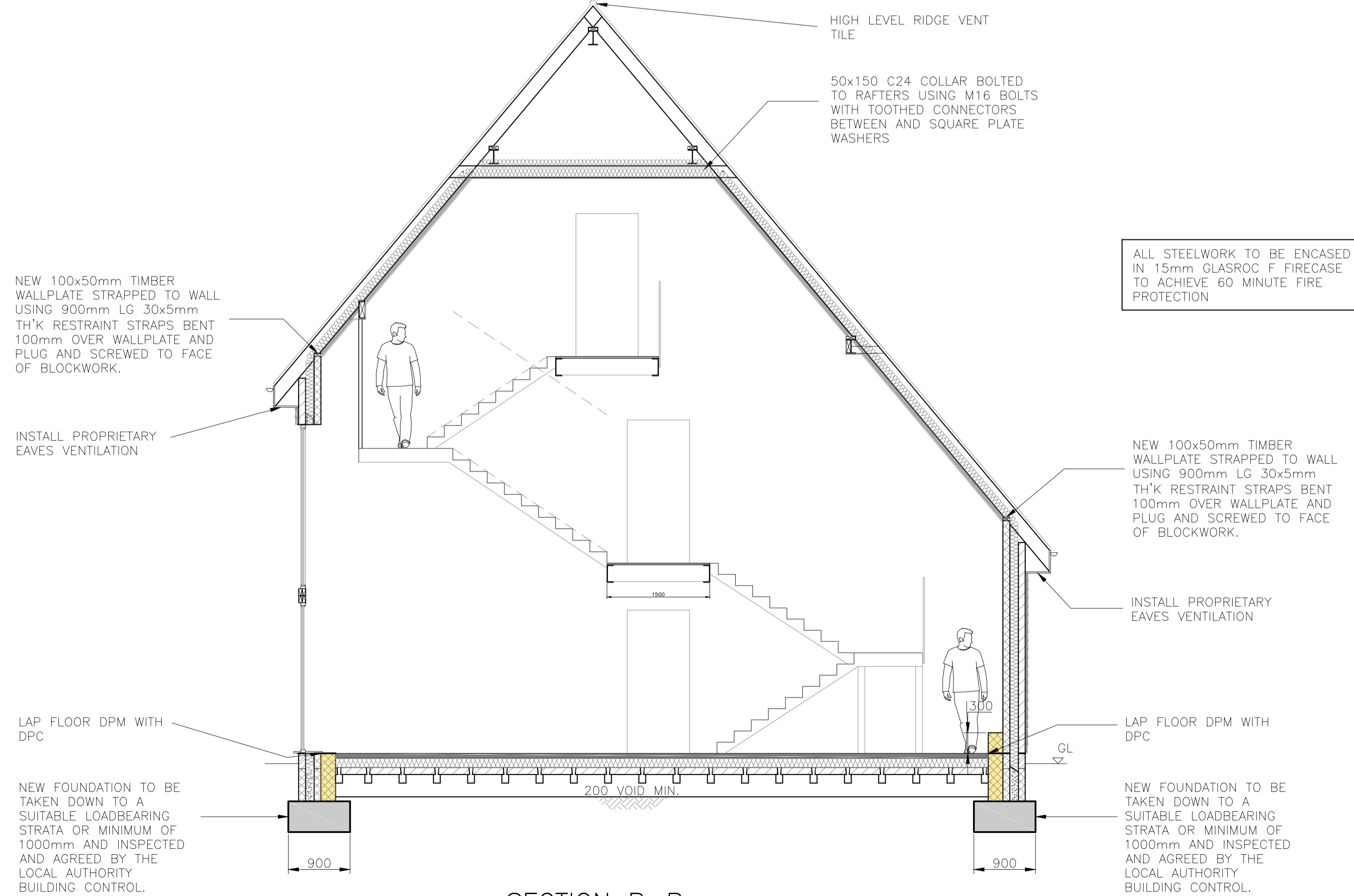

SECTION B-B
SCALE 1:50

REFERENCE DRAWINGS			
REV	DATE	REVISION	OR REVIEW

Orange Key
 Unit 4, The Cuttings
 120 High Street, Hungerford
 Berkshire, RG17 0LU
 Tel: (01488) 622918
 E-mail: info@orangekeyltd.co.uk

Client JAMES DANIEL CONSTRUCTION	
Project GREATER BARN HUBBARDS FARM	
Title SECTIONS	
Scale AS SHOWN @ A1	Date OCT 2017
Originator GEL	Reviewed By
Drawing number 16092/GB111	Rev. P1

THIS DRAWING IS THE COPYRIGHT OF ORANGE KEY LTD. IT IS PRIVATE AND CONFIDENTIAL AND IS SUPPLIED ON THE EXPRESS CONDITION THAT IT IS NOT USED FOR ANY PURPOSE OR COPIED OR COMMUNICATED TO ANY OTHER PARTY WITHOUT THE WRITTEN CONSENT OF ORANGE KEY LTD.

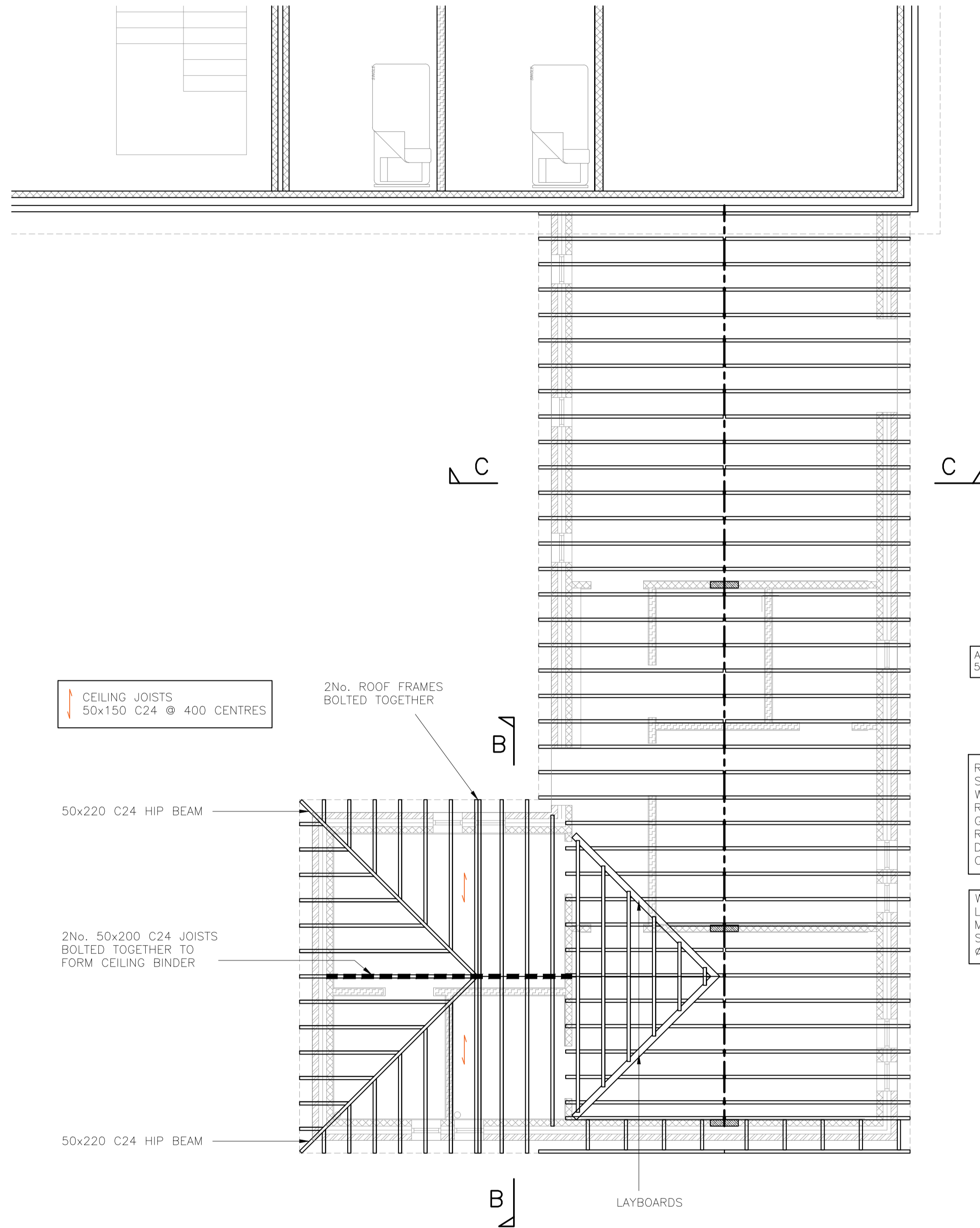

ALL NEW RAFTERS TO BE
50 x 150 C24 @ 400 CRS

ROOF JOISTS TO BE FULLY STRAPPED IN ACCORDANCE WITH THE BUILDING REGULATIONS USING 30x5mm GALVANISED LATERAL RESTRAINT STRAPS FIXED DOWN INSIDE FACE OF CAVITY WALL.

WHERE TIMBERS ARE SHOWN LAID TOGETHER, FIX USING M16 BOLTS @ NOMINAL 500 STAGGERED CRS INCL. Ø30mm WASHERS

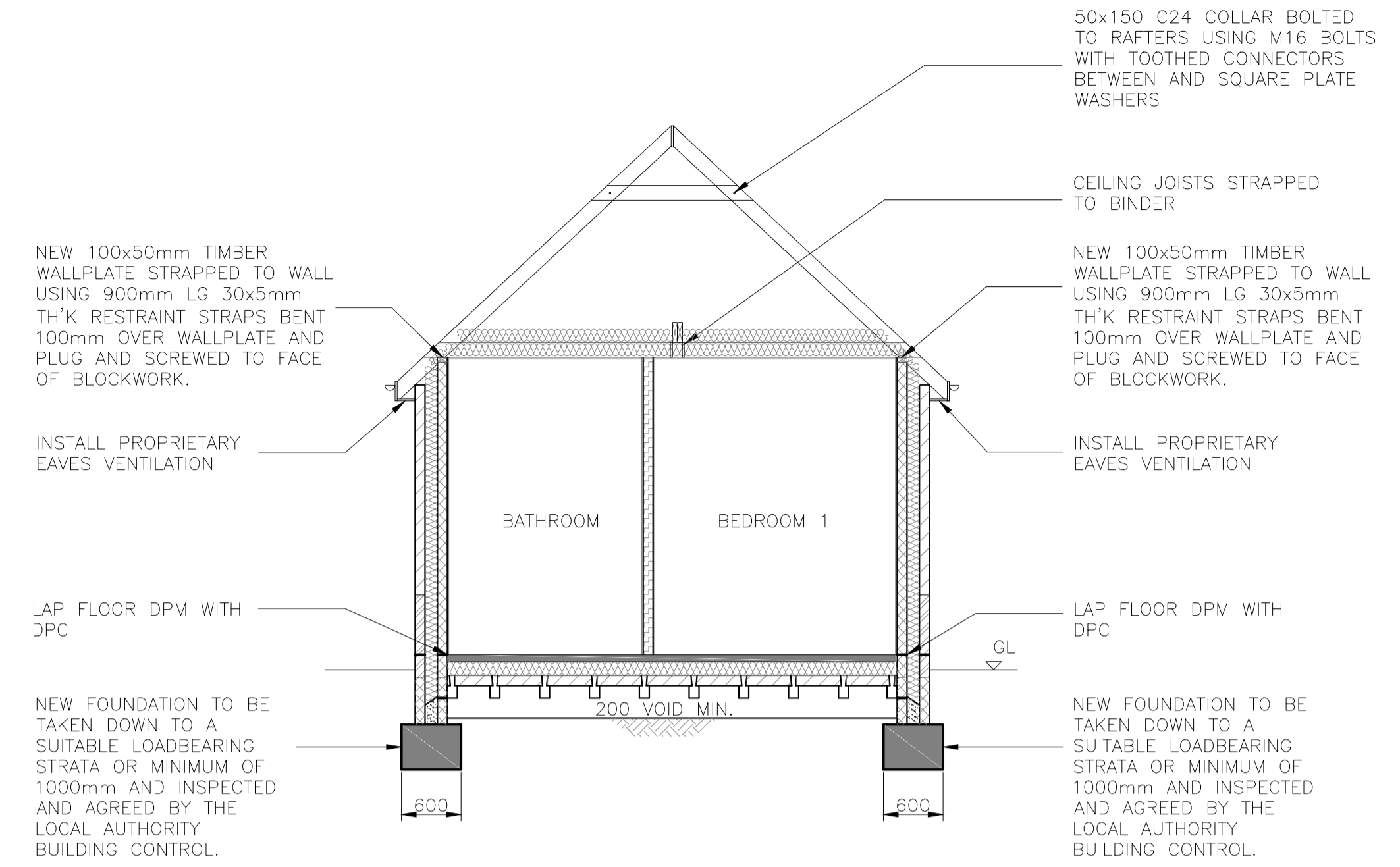

SECTION C-C
SCALE 1:50

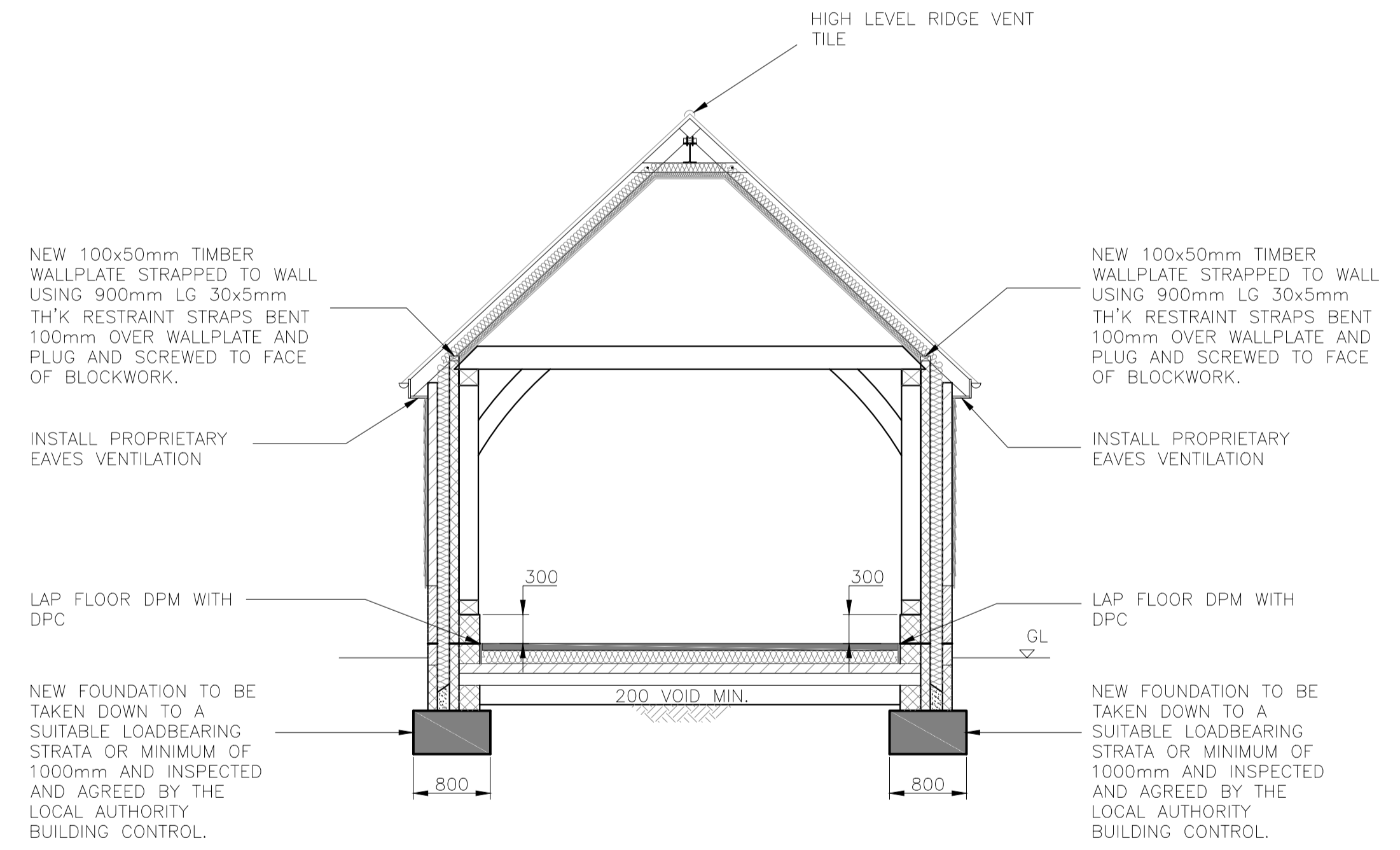

SECTION D-D
SCALE 1:50

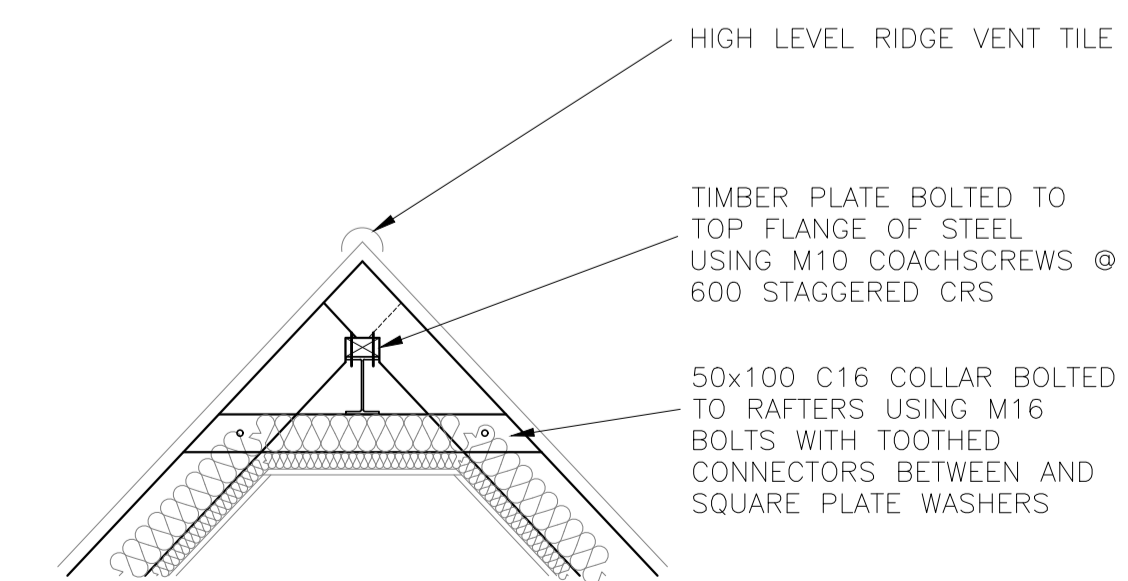

RIDGE DETAIL TO VAULTED ROOF
SCALE 1:20

REFERENCE DRAWINGS			
REV	DATE	REVISION	OR REVIEW



Unit 4, The Cuttings
120 High Street, Hungerford
Berkshire, RG17 0LU
Tel: (01488) 682918
E-mail: info@orangekeyltd.co.uk

Client
JAMES DANIEL CONSTRUCTION

Project
**GREATER BARN
HUBBARDS FARM**

Title
**PROPOSED ROOF LAYOUT AND
SECTIONS TO SINGLE STOREY
UNIT**

Scale AS SHOWN @ A1 Date OCT 2017

Originator GEL Reviewed By

Drawing number Rev.

16092/GB112

P1